



Roofit.solar
Photovoltaic metal roofs

Double Seam Installation Manual.

Please read Roofit.solar Safety Manual carefully before initiating any Roofit.solar system installation.

Roofit.solar Double Seam Panel

Roofit.solar panels are building integrated photovoltaic (BIPV) construction elements which replace conventional roofing and facade materials.

A Roofit.solar panel has two parts: an **overlapping area** and an **'active PV area'**. The overlapping area on top of the panel is designed to ensure a **waterproof connection** between the two adjacent panels on the roof. The overlapping area on the roof must be a **minimum of 200 mm**.

Electricity is produced in a thin active photovoltaic layer that covers the most part of the panel.

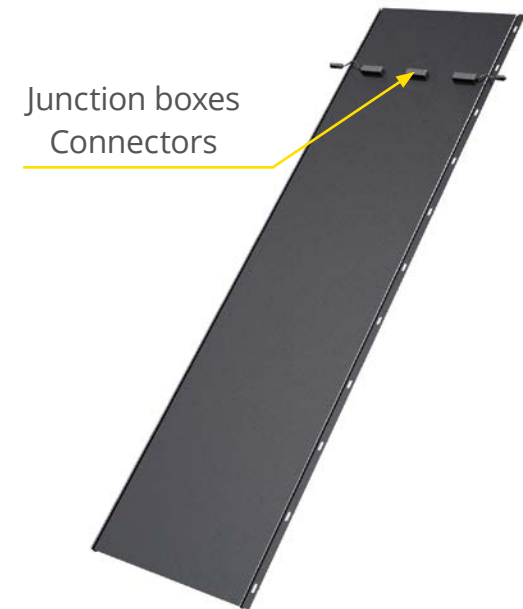
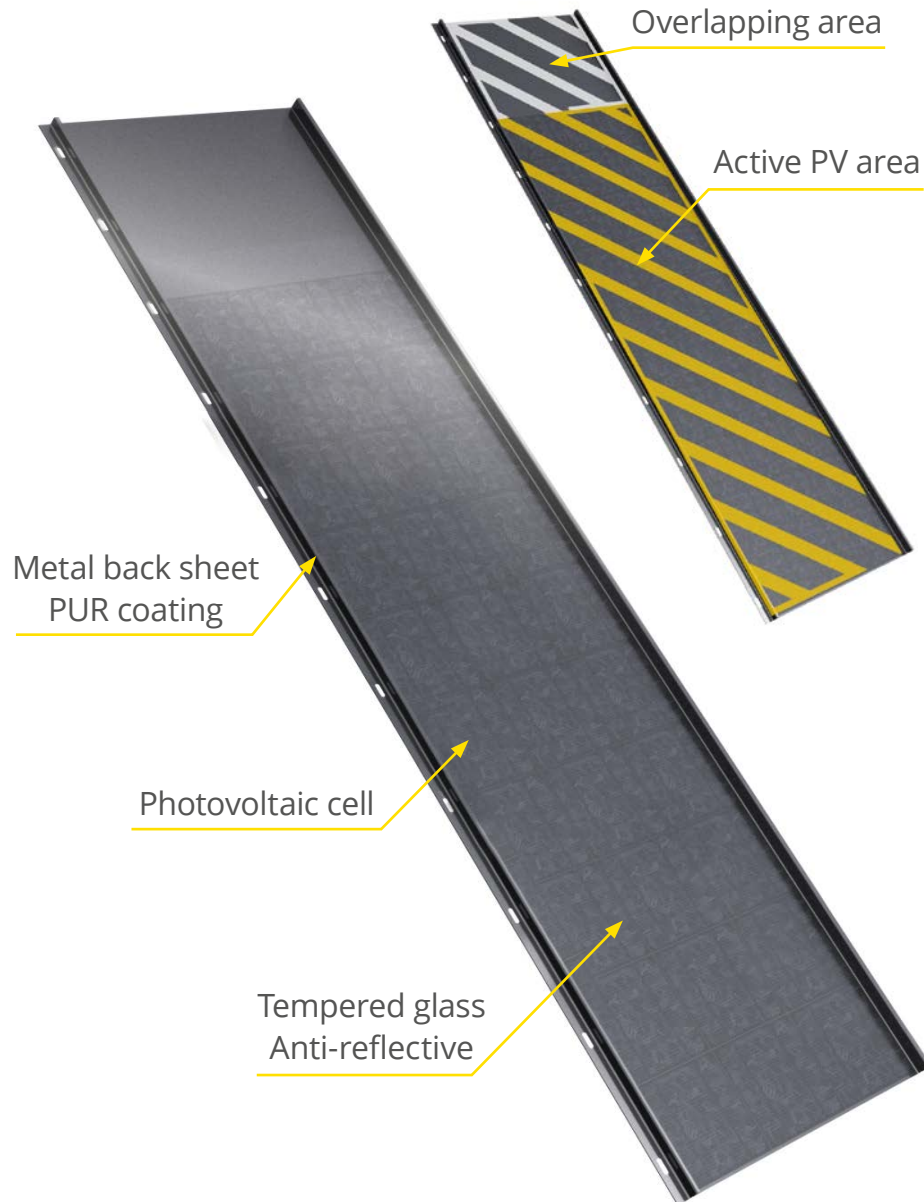

Installation Roof Accessories



Chimney Flashing



Chimney flashings are used to join the roof sheet and chimney together, ensuring that the roof repels water at the base of the chimney.

Gable Border



Gable borders are attached to the board of the end eave, finishing the edge of the roof and protecting it from dampness.

Eave Flashing



Eave flashings carry rainwater from the roof to the gutter.

Ridge Cap



Ridge caps are designed to cover the ridge of the roof and shield against seepage.

Valley Flashing



Valley flashings are installed before the profile sheet and followed by the roof slates.

Ridge Support Element



Ridge support elements are designed to more effectively fasten the ridge cap in place and provide complete water-proofing.

Overlapping Fastening Element



Overlapping fastening elements are designed to more effectively fasten overlapping areas. An overlapping element is laid using tape and then screwed into place.



Sealant

Sealant is designed to support adhesion between the overlapping areas of panels.



Screws

Flat-head self-tapping screws are designed to fasten

Double-sided Tape



Double-sided tape is needed to enhance the fastening of overlapping fastening elements.

Fastening Clamps



Fastening clamps are for fastening modules on to battens.

Seaming tools



Seaming tools are to seam locks and complete the roofing process.

Both the standing-seam/rolled profile roof system and the click system can be used with Roofit.solar panels. The installation of these systems is as easy as conventional roof installation.

1. Installation of Purlins and Rafters



1.1 Installation of battens which are the most common support structure in metal roof installations, plays an important role when installing Roofit.solar panels. Wooden blanks should be laid on top of the anti-condensation film covering the roof base **according to both the angle of the roof and the snow load.**

1.2 Double seam installation is applicable for roof inclination that exceeds 10 degrees (Fig. 1); **the battens should be laid every 250-300 mm**, parallel to the first fastened row (Fig. 2).

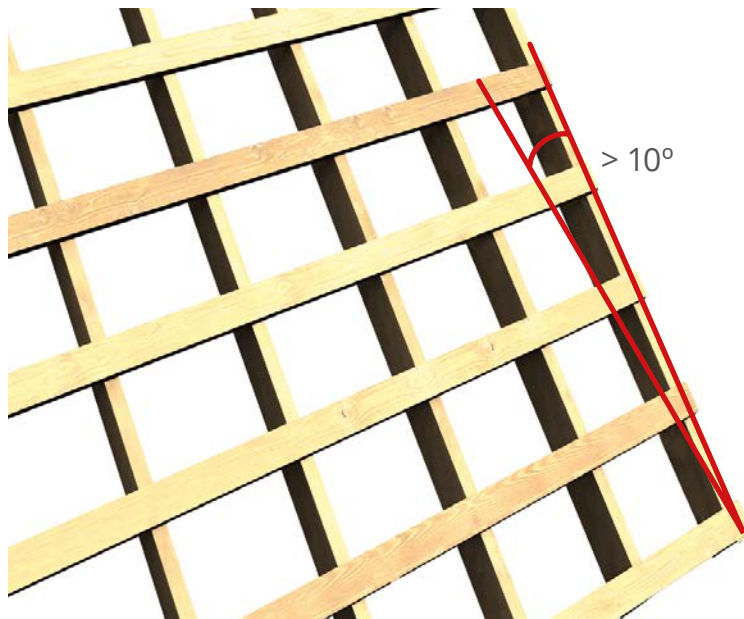

Fig. 1

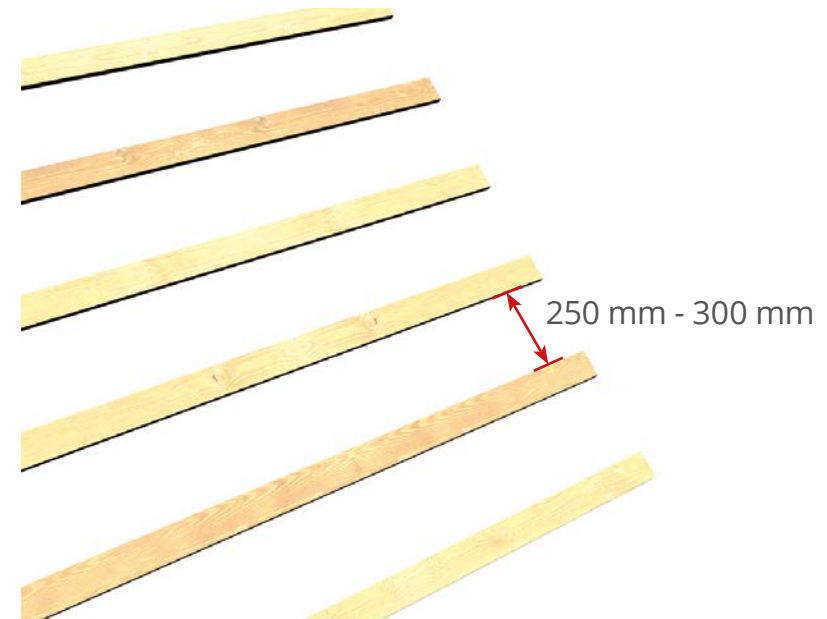

Fig. 2

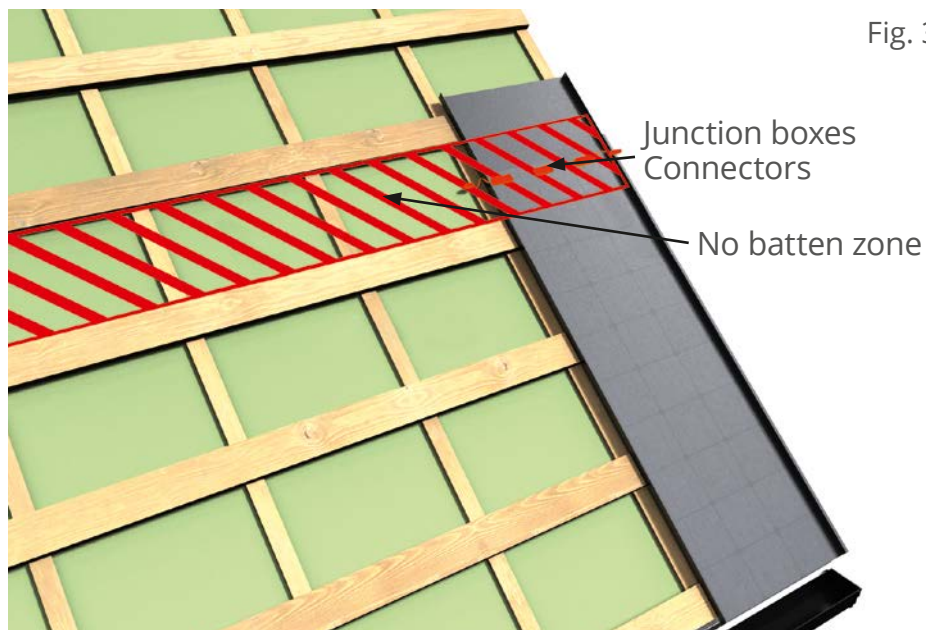

Fig. 3

1.3 If the snow load is high, battens can be laid more closely together on the lower side of the roof. **However, the cables of the Roofit.solar panels must run between the battens, so the battens must be installed accordingly.**

1.4 The **junction boxes** under each panel **must fit between two battens, without touching either (Fig. 3)**. The junction boxes are located behind the Roofit.solar panels, starting from the edge of the 'active PV area' and ending 50 mm below the 'active PV area' edge.

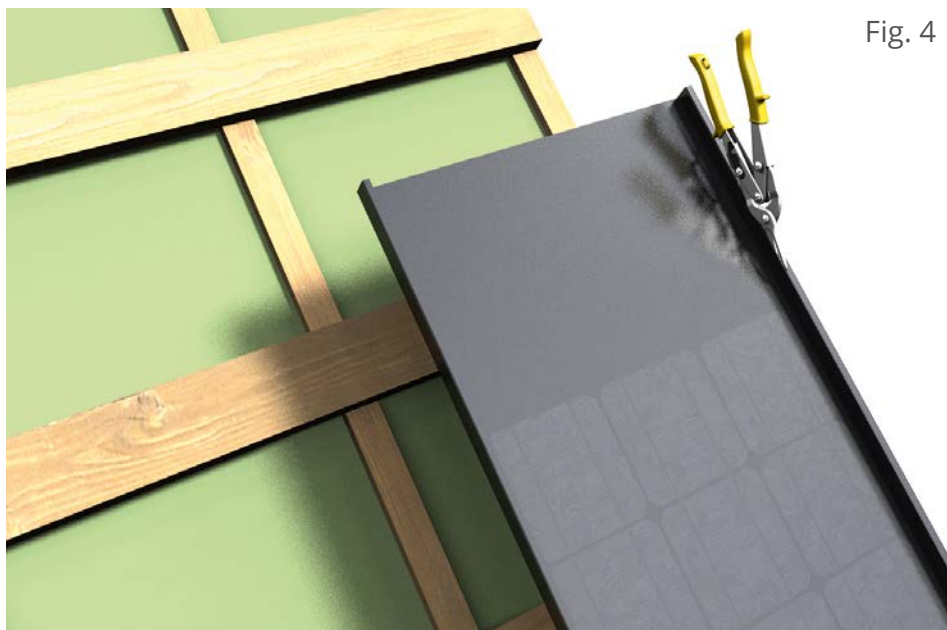

Fig. 4

2. Cutting Locks / Edges:

Depending on the length of the roof, the distance of the overlap (the point where one Roofit.solar panel joins another) may vary. **The overlapping area must be a minimum of 200 mm.** Due to thermal expansion, subsequent Roofit.solar panels which extend to the overlapping area should be **3 mm away from the previous panel.**

2.1 Cutting higher lock is shown accordingly in Figure 4, 4 a and 4b. Starting from line where the Roofit.solar module overlaps with the next one, the cut should start from outside of the lock with the angle of approximately 30 degrees as it is shown in Figure 4 a, till it reaches the edge. Then, the cut continues perpendicular to module alignment until it reaches the end of upper part of the lock. After that, the cut continues till the upper part of the lock is completely cut out as it is shown in Figure 4 b.

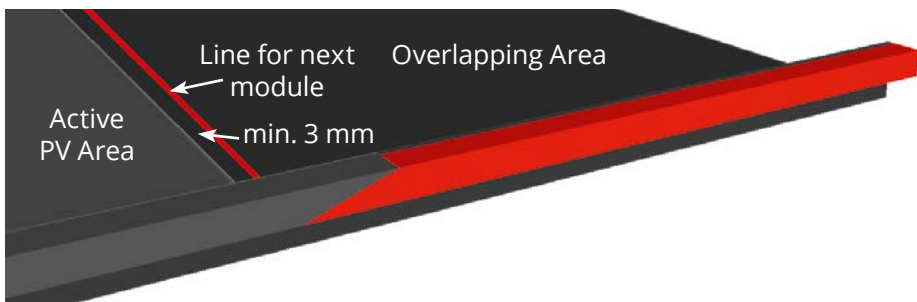

Fig. 4 a

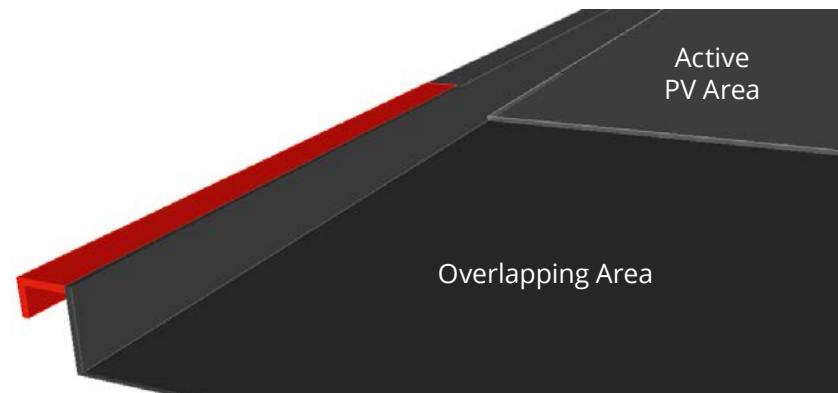

Fig. 4 b

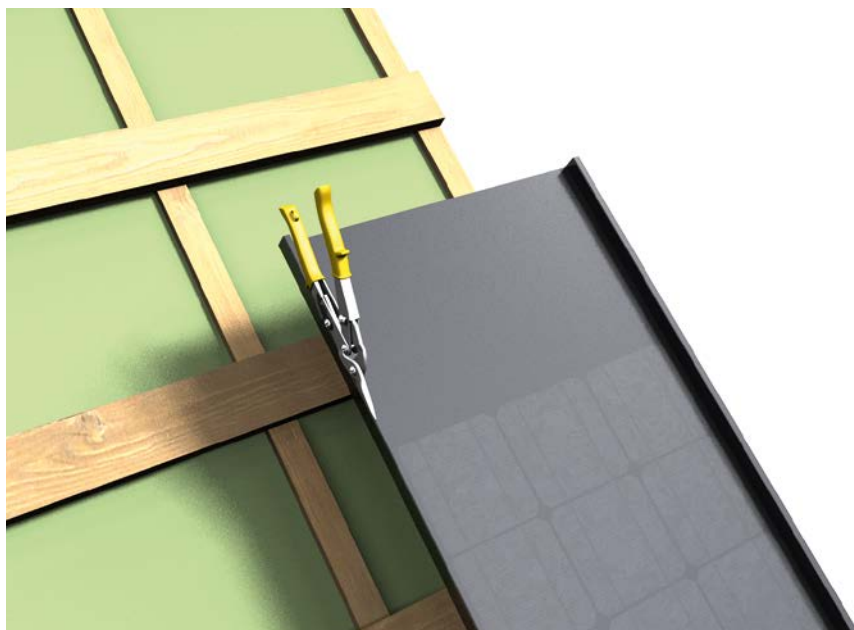

Fig. 5

Cutting higher lock is shown accordingly in Figure 5 and 5 a. Starting from the line where the next Roofit.solar module comes, the cut starts continues vertically to module alignment, until the upper part of the lock reached to an end (Fig. 5 a)

Then, the cut continues parallel to alignment until all upper part of the lock is cut off.

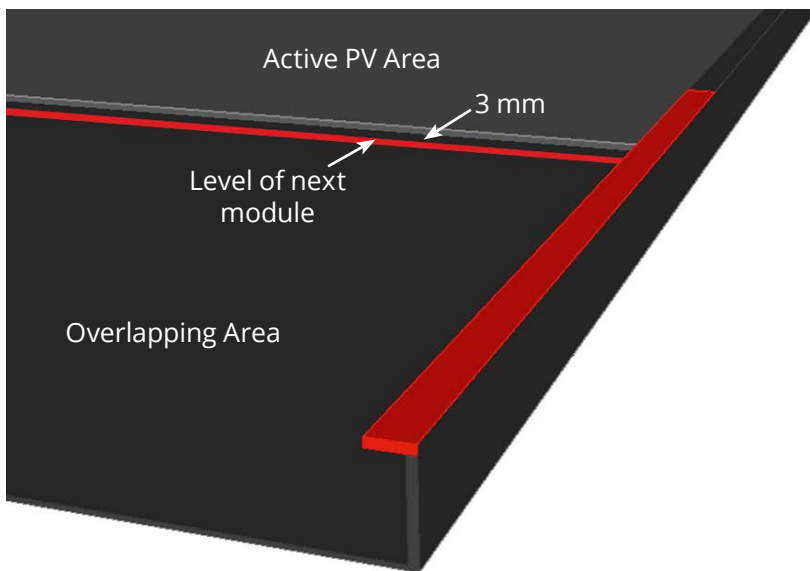
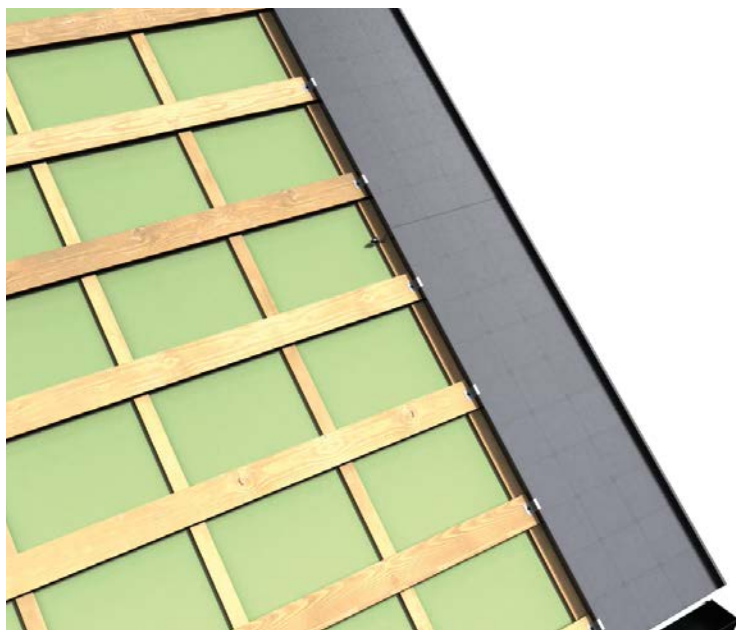

Fig. 5 a



3. Installation of First Column

Since Roofit.solar has an active PV area that must not be bent or folded, the first column touching the gable border should consist of regular metal panels.

3.1 After the installation of the rain shadow border, the first Roofit.solar panel should be installed running from right to left, perpendicular to the rain shadow line and parallel to the gable channel.

3.2 The joining edge of the Roofit.solar panel must be **cut from the locks till the 'active PV area'** in order to enhance fastening on the overlap as it was shown in **Section 'Cutting Locks/Edges'**

3.3 The **bottom of the lowest Roofit.solar panel that extends to the eave cannot be cut and folded** like a regular metal panel. The 'active PV area' on Roofit.solar panels provide excellent water-tightness and prevents metal expansion due to temperature increase.

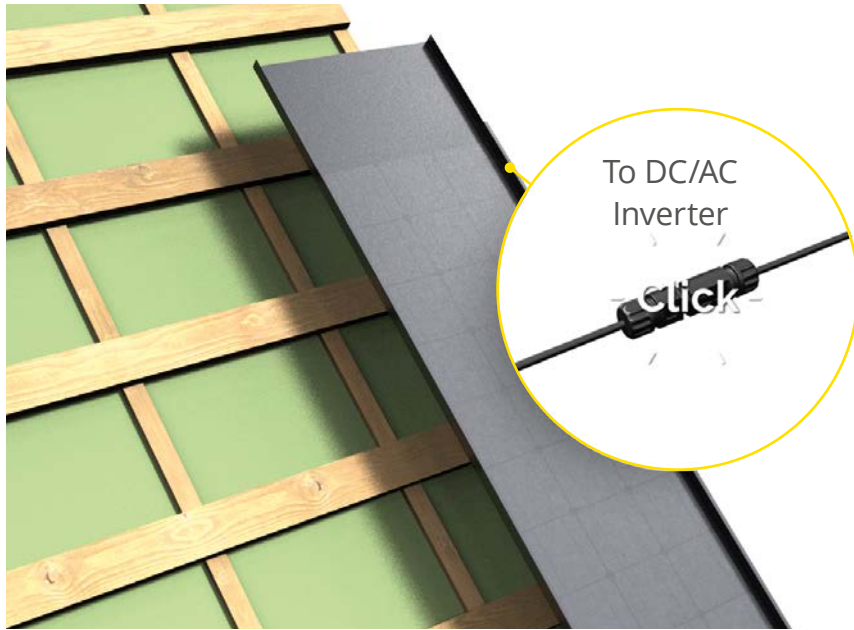

Fig. 6

3.4 Junction box cables should be in reachable position before fastening the panels to the battens. The Roofit.solar panels on the roof will form electrically one or several series-connected strings whose ends are connected to the inverter (Fig. 6). **Make sure that the cables are engaged till the very end and 'clicked'.**

3.5 The cable dust caps, which provide protection from moisture and the outside environment, **must be removed immediately prior to making the click connection between the MC4 connectors** (Fig. 7).

3.6 After placing the bottom part on the rain gutter, **higher lock (right side) of the first column will be fastened by using fastening clamps to the battens.** The clamps will be laid in approximately every 400 mm (Fig. 8).

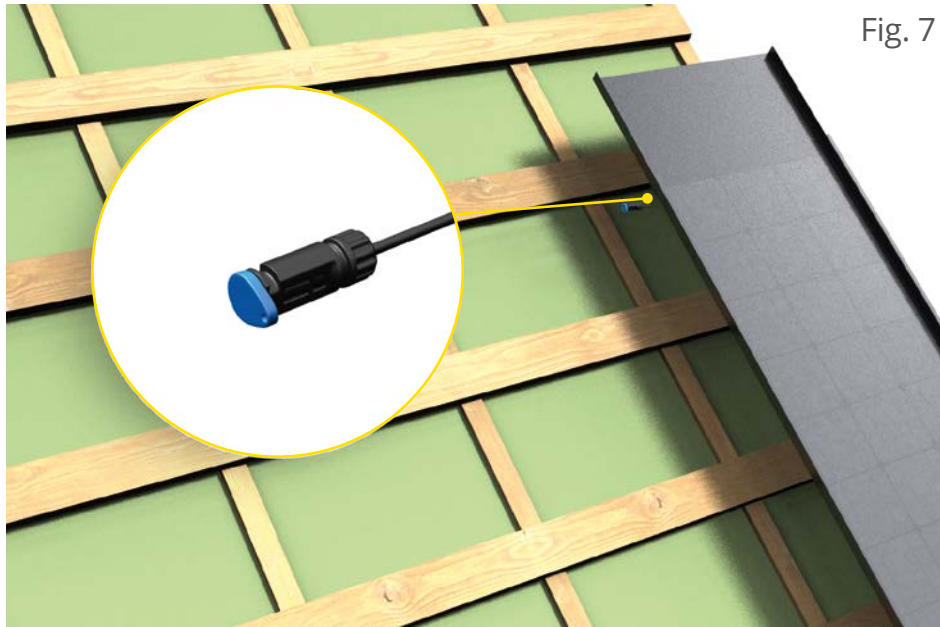

Fig. 7

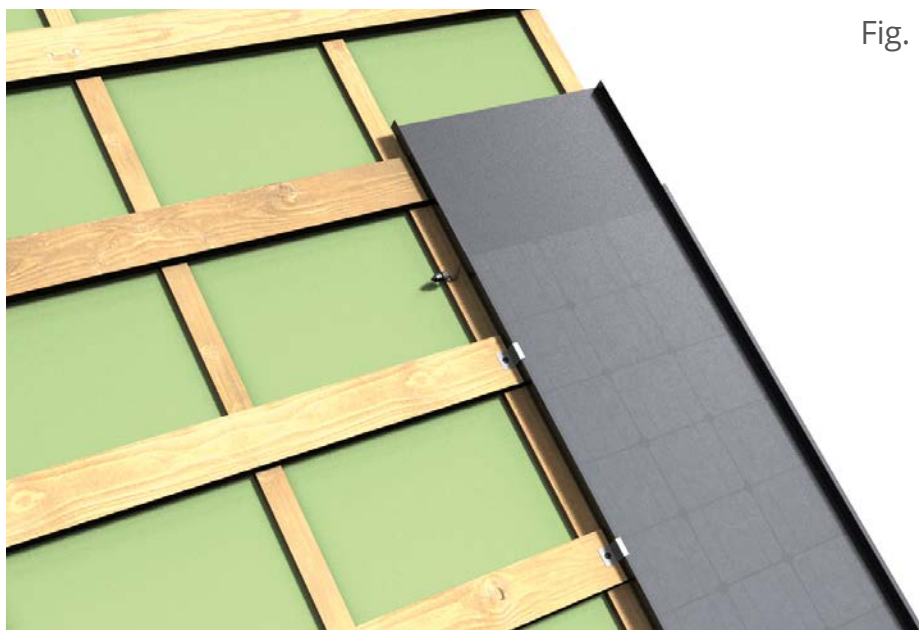

Fig. 8

3.7 Left side of the first column and upcoming Roofit.solar or regular metal panels must also be fastened to the battens **by fastening clamps that lay every 400 mm** after ensuring the junction box cable must be accessible later (Fig. 8).

3.8 The upper part of the panel (where the overlapping area is) should then be prepared for the second panel by using **three layers of adhesive sealant** (Fig. 9).

3.9 The second row and remaining upper rows of the first column are fastened in the same way.

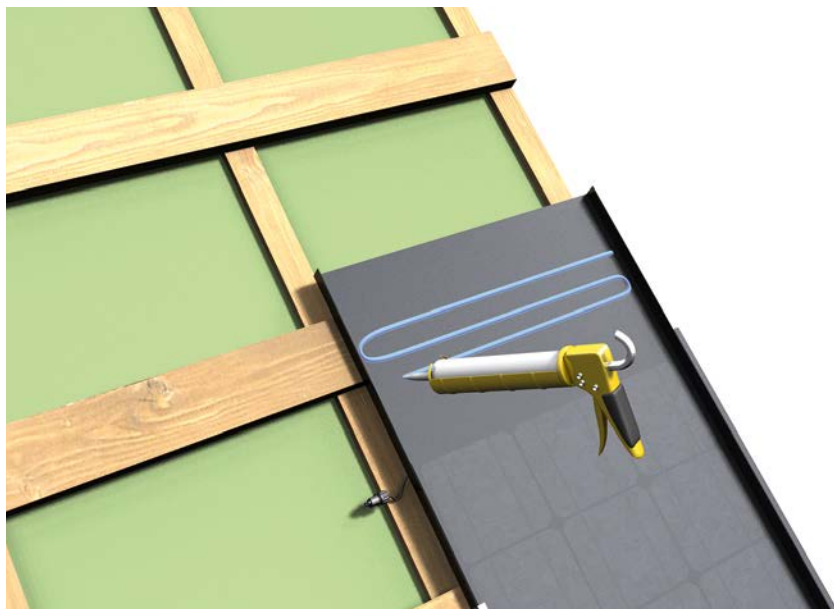

Fig. 9

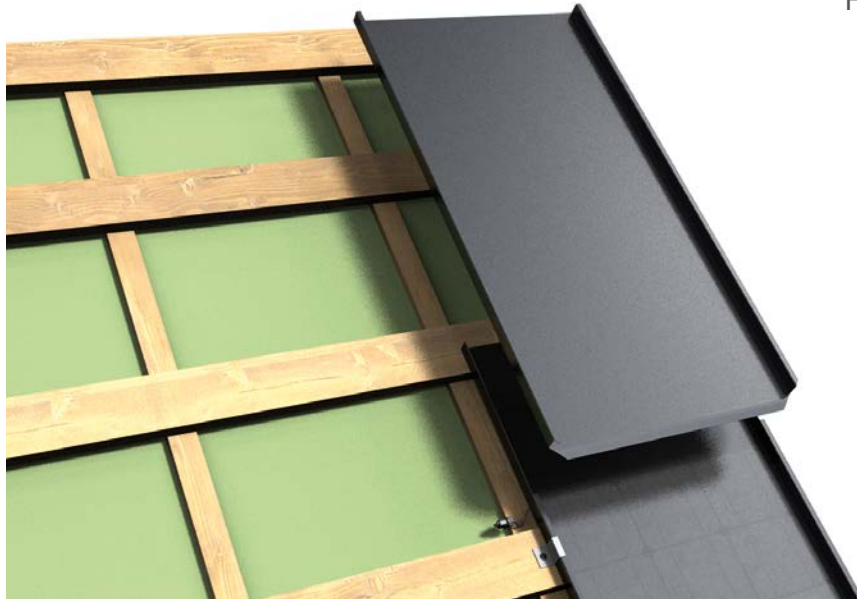

Fig. 10

3.10 In cases for upper rows of any column are covered with regular metal panel rather than Roofit.solar panel, overlapping must be made by:

- a.** First, cutting the locks of regular metal panel as in Roofit.solar module as it is shown in Section 'Cutting Edges/Locks'.
- b.** Leaving a 25 mm space for folding (Fig.11).
- c.** Putting double tape to the overlapping area of Roofit.solar panel that will join regular metal panel (Fig. 12).
- d.** Fastening small overlapping element by flat headed screws (Fig. 13).
- e.** Then placing folded part of regular metal panel that was prepared under the fastened small overlapping element (Fig. 14).

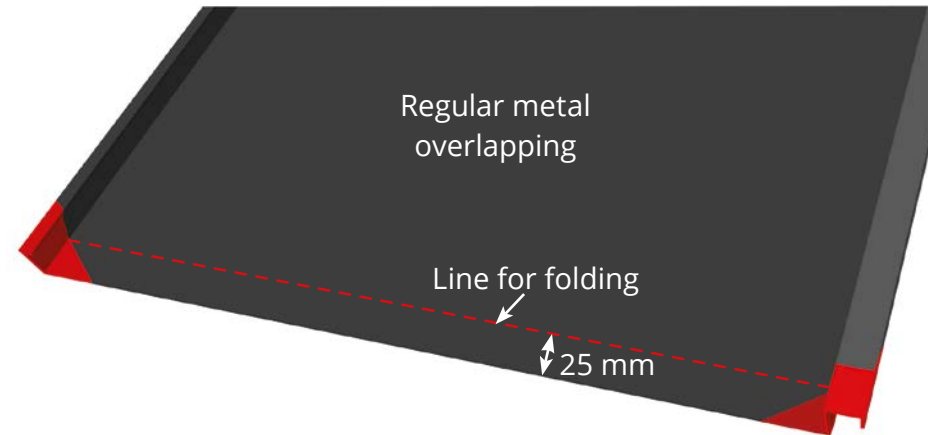

Fig. 11

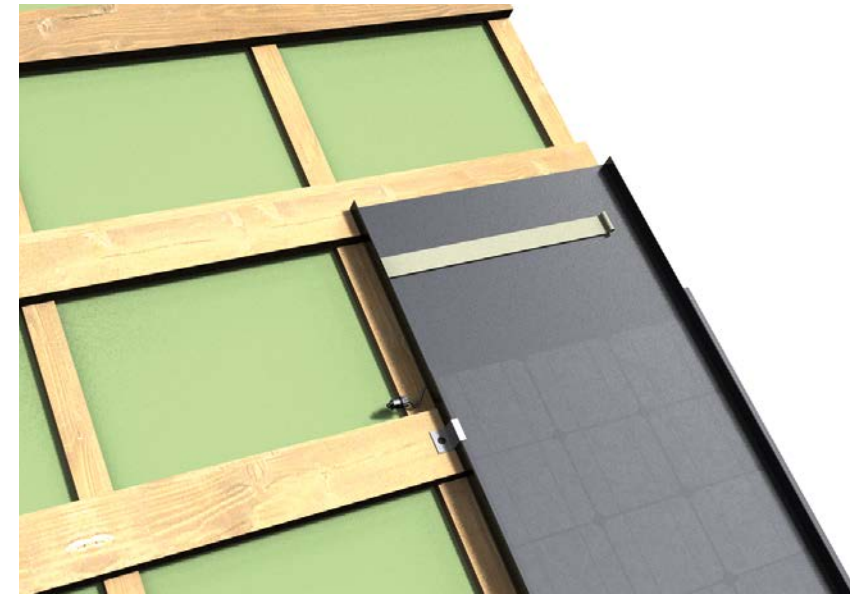

Fig. 12

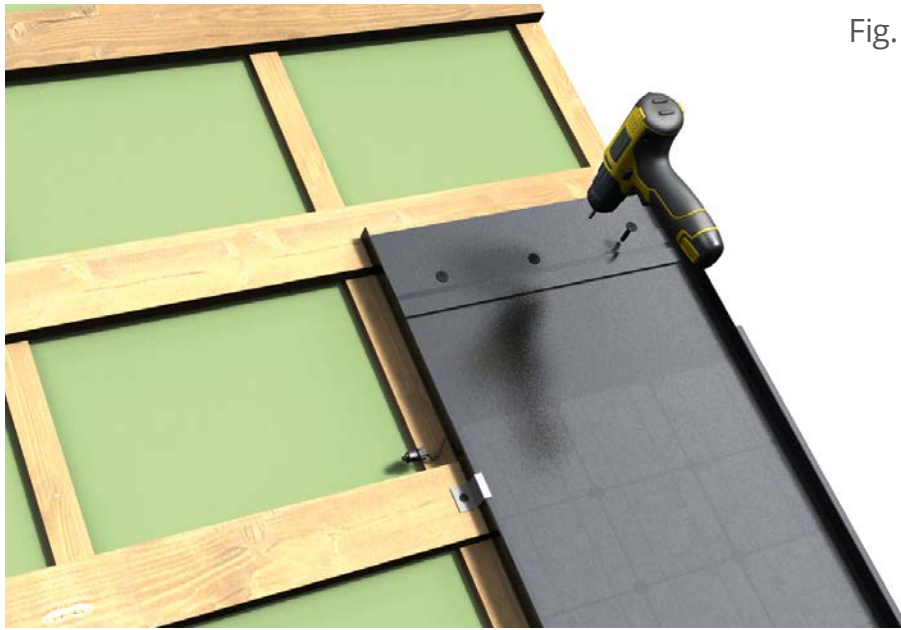

Fig. 13

3.11 In case where upper rows of any column is covered with Roofit.solar modules, then overlapping process is the same (putting three layers of sealant).

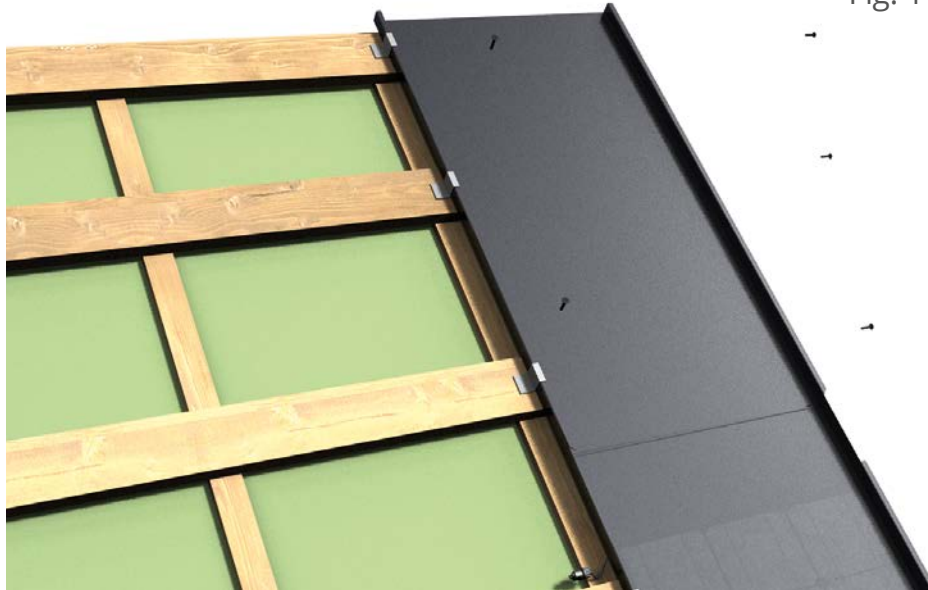

Fig. 14

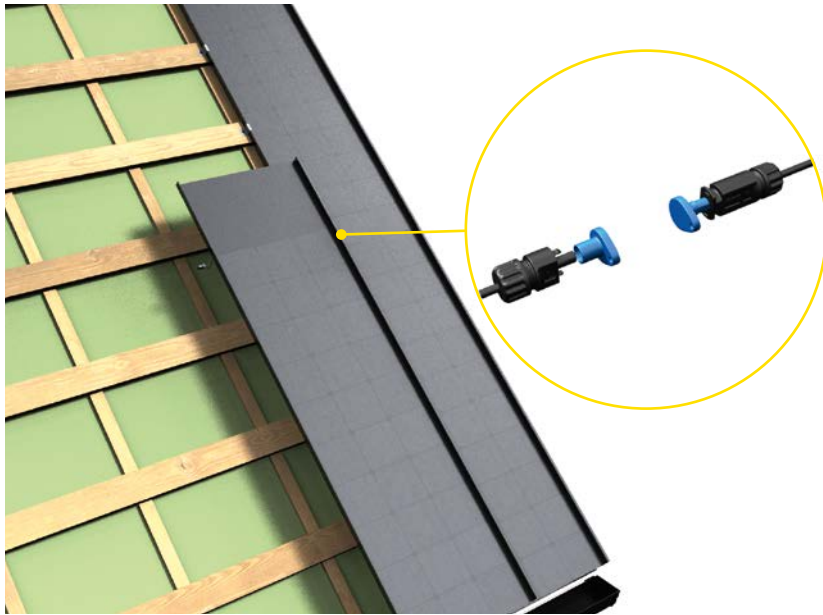

Fig. 15

4. Installation of Second Column and the Rest

4.1 Once first column is fastened on the roof, **second and the rest of the columns are fastened after junction cable are connected** (Fig. 15), and the locks are seamed by first using first hand tool (Fig. 16 a), and double lock by using the second hand tool (Fig. 16 b).

Fig. 16

Fig. 16 a

Fig. 16 b



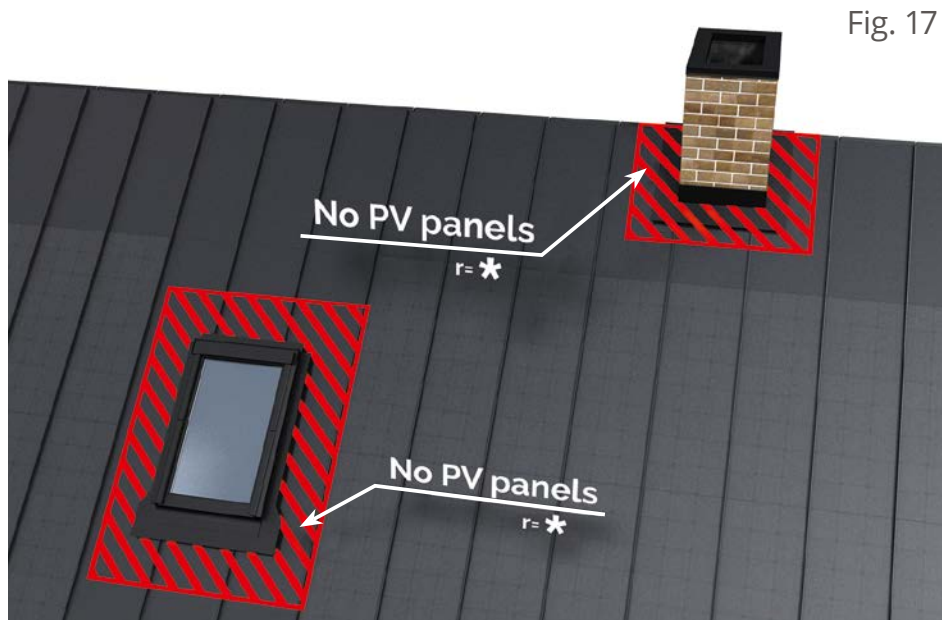

Fig. 17

5. Installation of Roofit.solar Panel around Roof Accessories

Since the active part of Roofit.solar panels must not be cut or bended, it is recommended to leave some distance around roof accessories such as eaves, gables, valley flashings, ridge tunnels, and window and chimney flashings.

5.1 The recommended distance for gables, chimney flashings, ridges, are 150 mm; for window flashings and valley flashings, the distance should be approx. 300 mm. Fastening a Roofit.solar module to the space around these roof elements at smaller distances is not possible, so these areas should be fastened with regular metal panels only.

These values may vary for each roofing material supplier. Consult a local roofing specialist to get your accessories dimensions before designing the PV system (Fig. 17).

5.2 Apart from chimney flashing, a distance as equal as height of the chimney must be spared from Roofit.solar modules due to shadow. This 'height rule' applies to all external erupted parts on the roof including dormers and ventilation tubes.

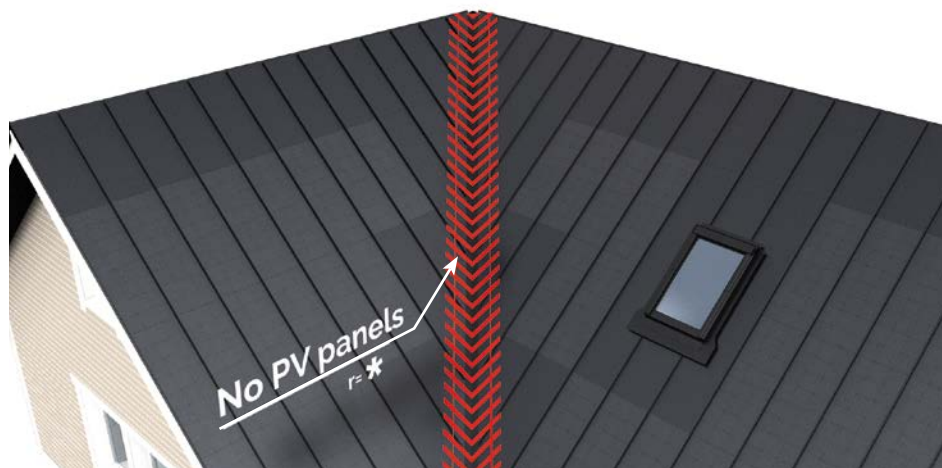

Fig. 18



Fig. 19

5.3 In cases where a valley flashing extends to the overlapping metal part of the Roofit.solar panel, the overlapping metal part should be marked and cut following the line of the overlapping element of the valley flashing already installed (Fig.18).

5.4 Apart from chimney flashing, a distance as equal 1. In areas where the overlapping metal part is diagonally cut as in Figure, the cut should start at least 100 mm from the active area. **Do not cut or bend the metal closer than 100 mm to the 'active PV area'** (Fig. 19).

5.5 Roof accessories like chimney and window flashings, ridge caps and gable borders can easily be installed as on regular metal roofs.

5.6 Before installing the ridge cap, the uppermost Roofit.solar panel which extends approx. to the middle of the roof length must be selected **to ground the installed system** (Fig. 20).

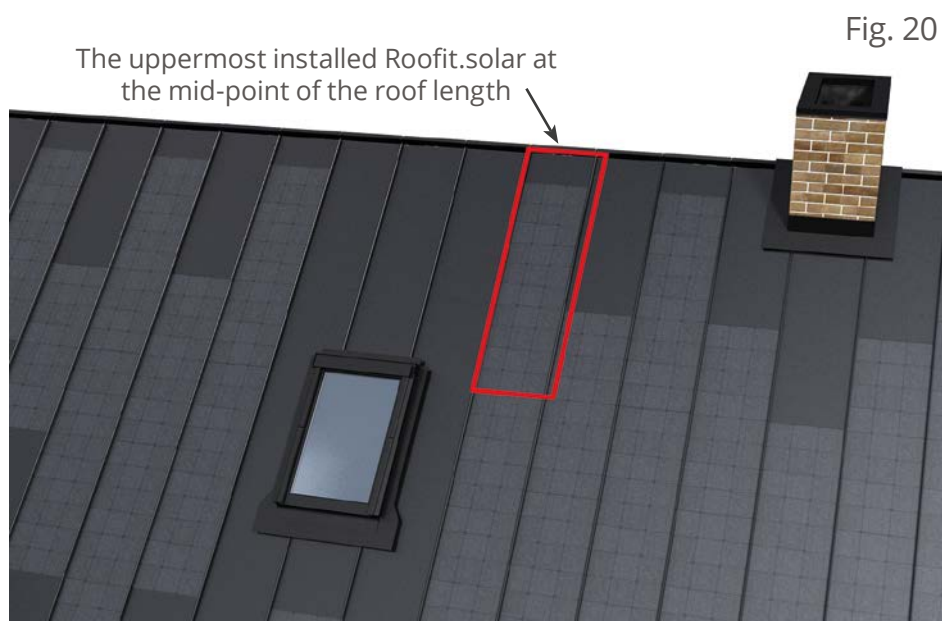
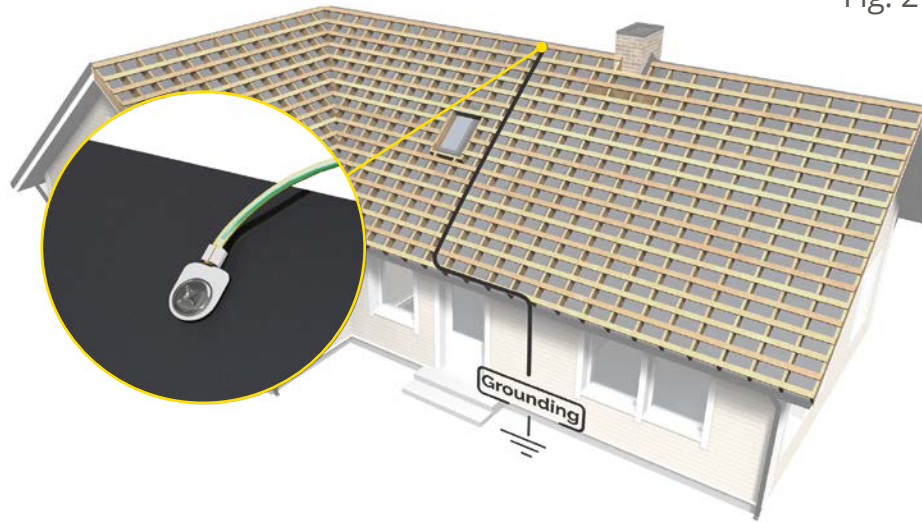

Fig. 20

The uppermost installed Roofit.solar at the mid-point of the roof length

Fig. 21



5.7 Grounding should be initialized by screwing the **6-mm² grounding conductor of the uppermost Roofit.solar module** from its overlapping area **to the batten** and is **finalized by connecting the grounding conductor to the house grounding** (Fig. 21). The house grounding screw must be under the ridge cap.

